



Green Bay Composite Decking Systems Green Bay Decking

Initial Acceptance Date: June 20, 2019

Expiration Date: June 20, 2022

Revision Date: June 20, 2020

TYPE OF ACCEPTANCE:

Product Material – Wood and Plastics

CSI Specification Division 065000 (Structural Plastic) and 065300 (Plastic Decking)

MANUFACTURER IDENTIFICATION:

Green Bay Decking
1518 South Broadway
Green Bay, WI 54304
1-877-804-0137
www.greenbaydecking.com

RESEARCH REPORT SUBJECT:

Green Bay Decking Deck Boards, Stair Treads, and Guardrail Systems for Exterior Applications. Installation on construction complying with the International Residential Code® (IRC®) or with the International Building Code® (IBC®) and IBC Exceptions in Section 1015.3 of the International Building Code.

DESCRIPTION OF BUILDING COMPONENTS:

A. Deck Boards – Green Bay Composite Decking Systems

Green Bay Decking deck boards are identified by the product name after each number. The deck boards are thermoplastic composite lumber products consisting of plastic (HDPE), filler (minerals and rice hulls) plus additives, and color. The product specifications are listed in the approved quality control manual. The Green Bay Decking deck boards are manufactured in several colors by the mono-extrusion process.

1. Deck Board: Classic GEODECK™ (Traditional)

- (a) The **Classic GEODECK** deck board is rectangular in shape, has rounded edges, four (4) rectangular hollow openings separated by three (3) rib stiffeners, and can also be used for stair treads. This deck board is also named **Classic TerrainDeck™**. See attached drawing in Table 1.

2. Deck Board: Classic GEODECK (Tongue and Groove)

- (a) The **Classic GEODECK** deck board is a tongue and groove design that is rectangular in shape, has rounded edges, three (3) rectangular hollow openings separated by two (2) rib stiffeners, and can also be used for stair treads. This deck board is also named **Classic TerrainDeck**. See attached drawing in Table 1.

3. Deck Board: Classic GEODECK (Heavy Duty)

- (a) The **Classic GEODECK** deck board is a heavy-duty commercial plank, is rectangular in shape, has rounded edges, five (5) rectangular hollow openings separated by four (4) rib stiffeners and can also be used for stair treads. This deck board is also named **Classic TerrainDeck**. See attached drawing in Table 1.

4. Deck Board: I.Dekk™ (Traditional)

- (a) The **I.Dekk** deck board is rectangular in shape, has rounded edges, four (4) rectangular hollow openings separated by three (3) rib stiffeners, and can also be used for stair treads. This deck board is also named **TerrainDeck**. See attached drawing in Table 1.

5. Deck Board: I.Dekk (Tongue and Groove)

- (a) The **I.Dekk** deck board is a tongue and groove design that is rectangular in shape, has rounded edges, three (3) rectangular hollow openings separated by two (2) rib stiffeners, and can also be used as stair treads. This deck board is also named **TerrainDeck**. See attached drawing in Table 1.

6. Deck Board: DuxxBak™

- (a) The **DuxxBak** deck board is rectangular in shape that has interlocking legs on both sides of the deck board, has rounded edges, and three (3) rectangular hollow openings separated by two (2) rib stiffeners. This deck board cannot be used for stair treads. See attached drawing in Table 1.

7. The Green Bay Decking deck boards must be installed as indicated in the manufacturer's published installation instructions as follows: GeoDeck dated September 1, 2017, I.Dekk dated May 16, 2017, and DuxxBak dated June 8 and June 28, 2017.

B. Guardrails - GeoRail™ Composite Guardrail

Green Bay Decking guardrail is identified by the name – **GeoRail Composite Guardrail**. The guardrail system is for use in areas as referenced in the applicable sections of the codes noted in this Report. The guardrail system provides a protective barrier for balconies, porches, stairs, and ramps. The guardrails are thermoplastic composite lumber products consisting of plastic (HDPE), filler (minerals and rice hulls) plus additives, and color. The product specifications are listed in the approved quality control manual. The Green Bay Decking guardrail is manufactured in several colors.

1. Guardrail – GeoRail Composite Guardrail

- (a) The guardrail system consists of a top rail, bottom rail, balusters, and reinforcing stiffener insert. The top rail, bottom rail, and balusters are manufactured by the mono-extrusion process except for the aluminum reinforcing insert and steel mounting brackets that conform to ASTM A1008 CS Type B. See Figure 1 for the schematic of the guardrail system.
- (b) The guardrail system has a top rail that is oval in shape. The top rail is hollow in the center and has rounded edges. The top rail has a standard reinforcing stiffener insert that is made of extruded aluminum 6061-T6 alloy material. The top rail is pre-routed for baluster installation. See Figure 1 in this Report for drawing and dimensions of top rail and stiffener. See Table 2 and 3 for the top rail and top rail stiffener installation requirements.
- (c) The guardrail system has a bottom rail that is oval in shape. The bottom rail is hollow in the center and has rounded edges. The bottom rail is pre-routed for baluster installation. See Figure 1 in this Report for drawing and dimensions of the bottom rail. See Table 2 and 3 for bottom rail installation requirements.
- (d) The guardrail system has a baluster design that is square in shape. The baluster is hollow in the center and has rounded edges. The baluster comes in two sizes. See Figure 1 in this Report for baluster drawings and dimensions. See Table 2 and 3 in this Report for installation requirements.
- (e) The guardrail system connections for the top and bottom rails to the supports are steel mounting brackets (ASTM A1008 CS Type B) that have a collar (plastic cover). The steel brackets and collars are secured to the posts with stainless steel screws suitable for use in preservative-treated wood. See Table 3 and Figure 1 of this Report for drawings of the steel bracket and collar, and the number of fasteners required for both installations.
- (f) The guardrail system connections for the balusters to the top and bottom rails are routed holes provided in both top and bottom rails. See Figure 1 of this Report for a drawing of top rail bottom rail, and balusters.
- (g) See Figure 1 in this Report for the guardrail system heights and lengths.
- (h) The guardrail system incorporates an intermediate bottom rail support (squash blocks) for both six (6) foot and eight (8) foot designs. The six (6) foot design has two (2) supports located at third points of the span and the eight (8) foot design has three (3) supports located at quarter points of the span. See Figure 1 of this Report for bottom rail supports.
- (i) See manufacturer's published installation instructions dated June 2014 for additional installation details.

2. Stairs – GeoRail Composite Guardrail

- (a) The **GeoRail™ Composite Guardrail** system can be used as a stair guard. The top rail, bottom rail, and baluster are the same components as indicated B (1) above. See Tables 2, 3, and Figure 1 in this Report for the stair top and bottom rails, balusters, top and bottom rail connections, and fasteners required.
- (b) When the guardrail is used with stairs, the guardrail must be installed in accordance with the applicable code, manufacturer's published installation instructions, noted in (c) below, and in accordance with information located in Tables 2, 3 and Figure 1 in this Report. When the manufacturer's published installation instructions differ from this Report, this Report governs. In order to comply with the IBC or IRC graspability requirements, a graspable handrail must be provided. Specific details regarding the construction, installation, and attachment of the graspable handrail to the stair guardrail and/or posts have not been evaluated and are outside the scope of this Research Report. Specific details when required must be furnished to the authority having jurisdiction.
- (c) See manufacturer's published installation instructions dated June 2014 for additional installation details.

3. Posts – GeoRail Composite Guardrail

- (a) The guardrail system has post sleeves. The post sleeves are manufactured with the same material as indicated in B above, are square in shape, hollow in the center, and have rounded edges. The post sleeves are non-structural and can be installed over conventional wood posts. Specific details regarding the construction installation for the post sleeves and/or posts have not been evaluated and are outside the scope of this Research Report. Specific details when required must be furnished to the authority having jurisdiction. See Figure 1 of this Report for post sleeve drawing and dimensions.

APPLICABLE CODES:

- *International Building Code (IBC) - 2006, 2009, 2012, 2015, and 2018 editions*
- *International Residential Code (IRC) - 2006, 2009, 2012, 2015, and 2018 editions*

APPLICABLE CHARACTERISTICS REVIEWED:

C. Deck Board(s) See Section A – 1 thru 6 above for the identification and description of the deck boards reviewed.

1. Deck Board: Structural Performance

- (a) The deck boards have been reviewed for uniform load, and maximum span when installed on support framing members. See attached Table 1.
- (b) The deck boards used as stair treads meet the code prescribed load requirements including the concentrated load of 300 lbf when installed in accordance with the manufacturers' installation instructions and Table 1 in this Report.

2. Deck Board: Fastening

- (a) Deck Boards, solid and with side grooves and interlocking legs, must be fastened to the structural supporting members in accordance with the manufacturer's installation instructions and Table 1 in this Report. When the manufacturer's installation instructions differ from this Report, this Report governs.
- (b) When deck boards are used as stair treads, they must be installed in accordance with the manufacturer's installation instructions and Table 1 in this Report. When the manufacturer's installation instructions differ from this Report, this Report governs.
- (c) The uplift capacity for the deck boards must be designed by a licensed professional and submitted to the authority having jurisdiction for final acceptance.

3. Deck Board Durability: Temperature

- (a) The deck boards have been reviewed for the temperature range of -20 to 125 °F (-29 to 52 °C).

4. Deck Board Flame Spread Index:

- (a) The flame spread rating for the deck boards described in this Report was less than 200 when tested in accordance with ASTM E84, *Standard Test Method for Surface Burning Characteristics of Building Materials*.

5. **Deck Board Decay Resistance:**
 - (a) The deck boards reviewed for this Report have been deemed comparable to naturally resistant wood or preservative-treated wood for resistance to fungal decay.
 6. **Deck Board Termite Resistance:**
 - (a) The deck boards reviewed for this Report have been deemed comparable to naturally resistant wood or preservative-treated wood for resistance to termite attack.
 7. **UV Testing:**
 - (a) The UV testing was conducted, and an appropriate adjustment factor was applied in accordance with ASTM D7032, *Standard Specification for Establishing Performance Ratings for Wood-Plastic Composite Deck Boards and Guardrail Systems (Guards or Handrails)*.
- D. **Guardrail** See Section B – 1 thru 3 above for the identification and description of the guardrail reviewed.
1. **Guardrail: Structural Performance**
 - (a) The guardrail system has been reviewed for maximum spans as indicated in Table 2. Table 2 in this Report also indicates the limitations of use evaluated.
 2. **Guardrail: Temperature**
 - (a) The guardrail system has been reviewed for the temperature range of -20 to 125 °F (-29 to 52 °C).
 3. **Guardrail: Flame Spread Index**
 - (a) The flame spread rating for the deck boards described in this Report was less than 200 when tested in accordance with ASTM E84, *Standard Test Method for Surface Burning Characteristics of Building Materials*.
 4. **Guardrail: Decay Resistance**
 - (a) The material used in the guardrail system in this Report has been deemed comparable to naturally resistant wood or preservative-treated wood for resistance to fungal decay.
 5. **Guardrail: Termite Resistance:**
 - (a) The material used in the guardrail system in this Report has been deemed equivalent to naturally resistant wood or preservative-treated wood for resistance to termite attack.
 6. **Guardrail: UV Testing**
 - (a) The UV testing was conducted, and an appropriate adjustment factor was applied in accordance with ASTM D7032, *Standard Specification for Establishing Performance Ratings for Wood-Plastic Composite Deck Boards and Guardrail Systems (Guards or Handrails)*.
 7. **Guardrail: Fastening**
 - (a) The guardrail top rail must be fastened to posts with the collar bracket and the steel mounting bracket using screws identified in Table 3. See Table 3 in this Report and the manufacturer's published installation instructions noted in B-1(i) and B-2(c) above.
 - (b) The guardrail bottom rail must be fastened to the posts with the collar bracket using the screws identified in Table 3. See Table 3 in this Report and the manufacturer's published installation instructions noted in B-(1)(i) and B-2(c) above.
 - (c) The fasteners and brackets are supplied by the manufacturer and must be used in the installation of the Green Bay Decking guardrail system. Use of other brackets and fasteners is not covered under this Report. See manufacturer's published installation instruction noted in B.1(i) and B.2(c) above.

8. Guardrail: Posts

- (a) Wood posts or other wood framing members supporting the posts are not covered under this report and fall outside of this report. Wood posts and other wood must be designed to meet the load requirement in the applicable building code and the wood members must have a minimum specific gravity of 0.50 (southern pine or better) and a minimum thickness to allow full penetration of bracket mounting screws. Other wood posts or wood members not meeting these requirements are not covered under this Report.

APPLICABLE USES:

The Green Bay Decking deck boards and guardrail evaluated in this Report are limited to exterior applications for balconies, porches, stair treads, walking surfaces, and decks.

LIMITATIONS OF ACCEPTANCE:

The Green Bay Decking deck boards and guardrail described in this Report comply with those codes listed in Applicable Codes section above and are subject to the following conditions:

1. The deck board and guardrail products must be limited to Type V-B (IBC) and residential construction in accordance with the IRC for exterior use as a deck board for balconies, porches, decks, walking surfaces, and stair treads.
2. Installation of the deck boards and guardrail must comply with this Report, the manufacturer's published installation instructions (see Section A.7, B.1(i) and B.2(c) in this Report), and the applicable code. When the deck board manufacturer's installation instructions differ from this Report, this Report governs.
3. The fasteners described in this Report must be used for the installation of the Green Bay Decking deck boards and guardrails. The compatibility of the fasteners to treated supporting construction has not been evaluated.
4. The Green Bay Decking deck boards and guardrail indicated in this Report must be fastened to the supporting construction with the manufacturer's provided fasteners as indicated in the manufacturer's installation manual and outlined in this Report. When the deck board manufacturer's fastening instructions differ from this Report, this Report governs.
5. When required, the structural deck board layout must be designed by a design professional and submitted to the authority having jurisdiction for final acceptance.
6. The Green Bay Decking deck boards and guardrail have not been evaluated as a member of a fire-resistance-rated assembly.
7. The structural design for code compliance of supporting members for the deck boards has not been evaluated and is not part of this Research Report.
8. Green Bay Decking has a Third-Party inspection program provided by PFS Corporation.

DOCUMENTATION SUBMITTED:

Submitted data was provided in accordance with PFS TECO 1601 (Quality control manual, Specifications, Manufacturer's installation instructions, Test data, and Descriptive information) and the products have been evaluated in accordance with ICC-ES AC174, *Acceptance Criteria for Deck Board Span Ratings and Guardrail Systems (Guards and Handrails)*.

PRODUCT IDENTIFICATION:

The Green Bay Decking deck boards and guardrail evaluated in this Research Report must be identified with a label, stamp, or laser imprint on every deck board. The required information is as follows: Green Bay Decking, product identification, compliance to ASTM D7032 including the maximum deck board span (inches on center spacing of supports) and loading (psf), the Research Report number (RR 0125), and PFS Certification Mark (see image below). Deck boards without this information are not covered under this Report.

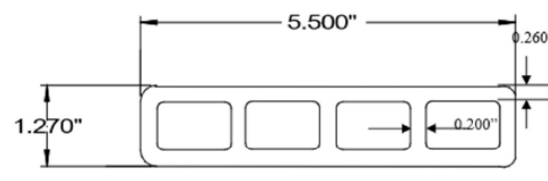
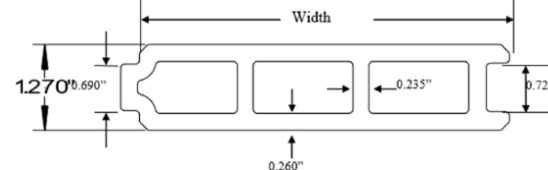
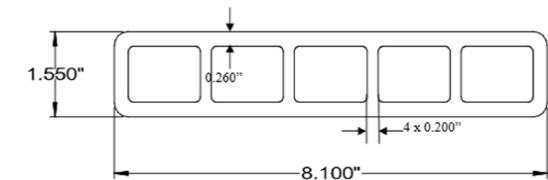
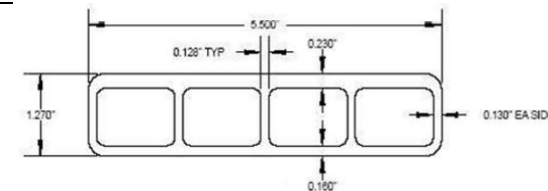
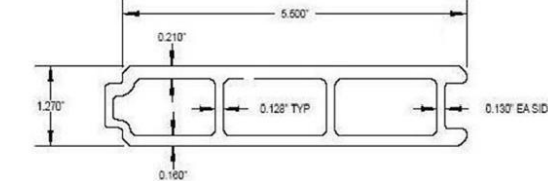
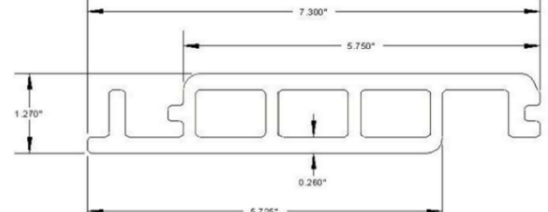

Table 1: Span Table and Fastening Schedule for Deck Boards

Product Trade Name	Deck Board Profile	Nominal Size	Shape	Maximum Span Rating (in) for Allowable Load ¹ (psf)		Maximum Stair Tread Span (in)
				60	100	
Classic GEODECK, Classic TerrainDeck		5/4 x 6	Traditional Board	24	24	16
		5/4 x 6	Tongue & Groove Board	24	24	16
		2x8	Heavy-Duty Commercial Plank	28	28	16
I.DEKK, TerrainDeck		5/4 x 6	Traditional S4S Board	21	16	12
		5/4 x 6	Tongue & Groove Board	21	16	12
DuxxBak		5/4 x 6	Interlocking Board	24	16	-n/a-

for SI conversion: 1 in = 25.4 mm, 1 psf = 47.9 Pa, 1 lbf = 0.0044 kN

¹ Tongue and Groove boards must be installed by a #7 x 2-1/4 inch long stainless steel (SS) or a #8 x 2-1/2 inch long SS or coated trim head screw, or an 8d by 2-1/2 inch long SS or coated ring shank nail. One fastener per joist, installed through the tongue, at a 55-60 degree angle. Traditional boards must be installed by a # 7 x 2-1/4 inch long SS or a No. 8 x 2-1/2 inch long SS or coated trim head screw, or an 8d by 2-1/2 inch long SS or coated ring shank nail. Two fasteners per joist, installed through the face of the board. Heavy-Duty Commercial Plank must be installed by #10 x 3.0-inch-long SS or coated deck screw or 10d x 3.0-inch-long SS or coated ring shank nail. Three fasteners per joist, installed through the face of the board. Interlocking Boards must be installed by # 7 x 1-1/2-inch-long SS or No. 8 x 2-1/2-inch-long SS or coated trim head screw, or 8d x 2-1/2-inch-long or coated ring shank nail. One fastener per joist, installed through the interlocking leg of the board. The

uplift capacity for the deck boards must be designed by a licensed professional and submitted to the authority having jurisdiction for final acceptance.

The joist to which the deck boards are attached must have a minimum specific gravity of 0.50 or better (treated Southern Pine), or the fastening must be designed.

Table 2: Span Table for Guardrail Assembly

Guardrail Type	Top Rail	Bottom Rail	Baluster	Post	Max Guardrail Span
Maximum Guardrail Height 36 in. for IRC Residential One- and Two-Family Residential Dwellings					
Level	1.9"x3.4 Rail with Aluminum Insert	1.9"x3.4 Rail	1.25"x1.25"	4x4" Standard Wood Post with Cover	8-ft
Maximum Guardrail Height 42 in. for IBC All Occupancies					
Level	1.9"x3.4 Rail with Aluminum Insert	1.9"x3.4 Rail	1.25"x1.25"	6"x6" Standard Wood Post with Cover	8-ft

for SI conversion: 1 in = 25.4 mm, 1 psf = 47.9 Pa, 1 lbf = 0.0044 kN

Refer to Table 3 for the fastening schedule.

Maximum span is clear length between posts measured parallel to top/bottom rail.

See Section D.8.(a) in this Report for additional requirements for the wood post.

Table 3: Fastening Schedule for Guardrail Assembly

Location	Connection	Fasteners
Level Top Rail	Bracket/Collar to Post	Four #8 x 2" stainless steel wood screw
	Bracket to Rail	One #8 x 1/2" self-drilling stainless steel sheet metal screw
Level Bottom Rail	Collar to Post	Four #8 x 2" stainless steel wood screw
Baluster	Inserted to Rails	No Fasteners

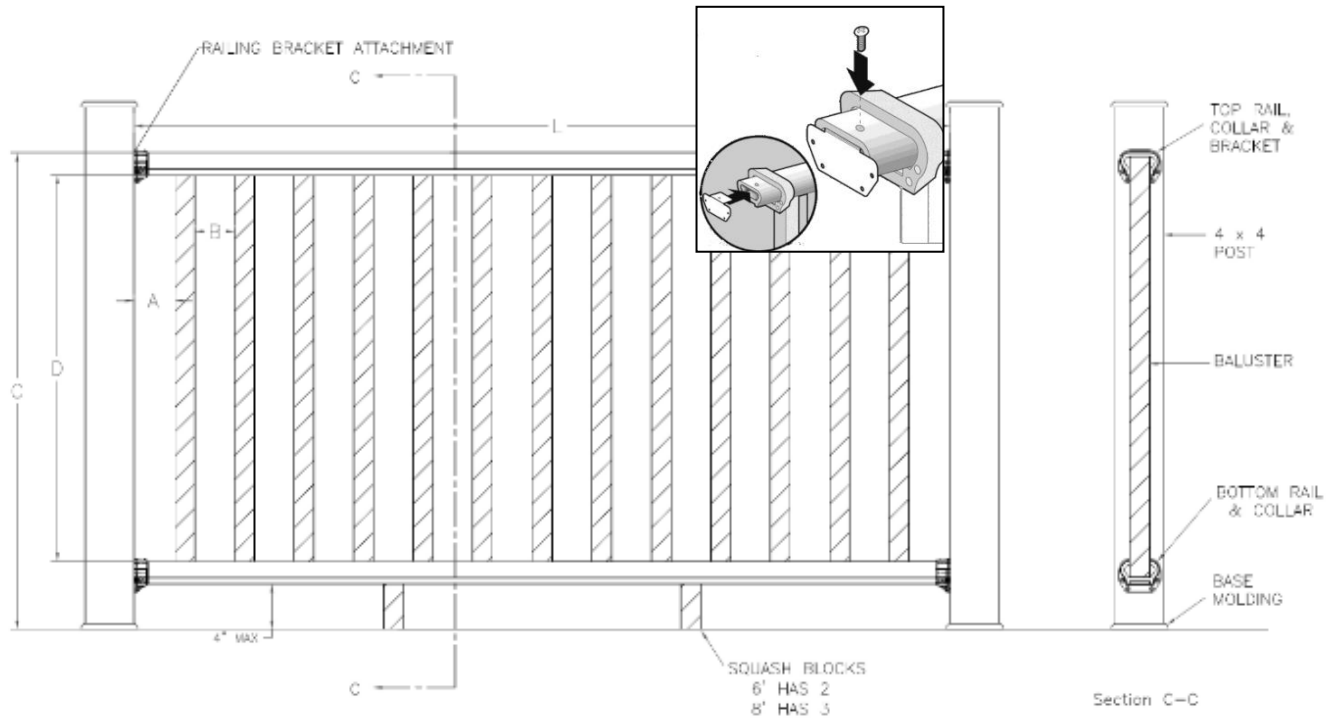

6' Rail: L=72 $\frac{3}{8}$ " A=3 $\frac{25}{32}$ " B=3 $\frac{1}{2}$ "
 8' Rail: L=96 $\frac{1}{16}$ " A=3 $\frac{3}{4}$ " B=3 $\frac{1}{8}$ "

36" Rail Height: C=36" D=28"
 42" Rail Height: C=42" D=34"

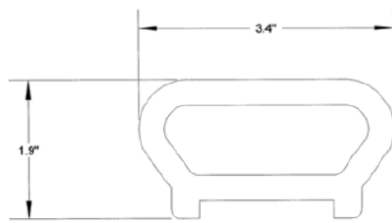

Bottom Rail

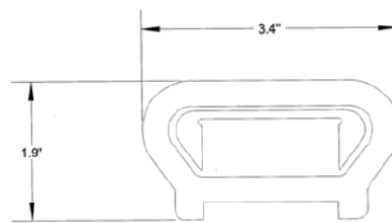

Top Rail with Reinforcement

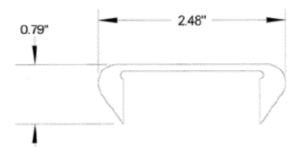

Aluminum Insert

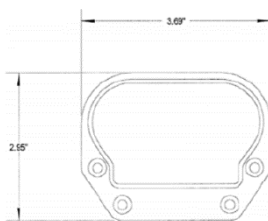

Collar



4x4 Post Sleeve

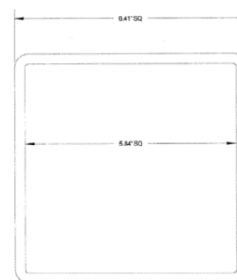

6x6 Post Sleeve

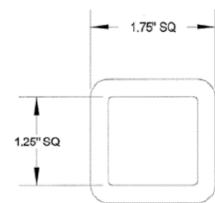

Baluster

Figure 1